

Electrical Ratings

Micro switch	Special Characteristics	Volt AC 50/60 Hz	Ind. Load A	Res. Load A	Volt DC	Ind. Load A	Res. Load A	Notes
H	Microswitch with silver contacts	125 250	10 10	10 10	6 to 24	0,50	0,5	Small hysteresis; high AC / low DC loads
M	Microswitch with silver contacts	125 250	10 10	10 10	12 24 250	5,00 1,00 0,25	15,0 2,0 0,4	Medium hysteresis; high AC and DC loads
GH	Microswitch with gold plated contacts for low voltage and low current	125	1	1	24	1,00	1,00	low change-back values
GM		30	0.1	0.1	30	0,10	0,10	Medium hysteresis

	IMPORTANT
480 V AC and 15 A only upon request	
We recommend to use a prefuse of the maximum current rating from the table above according to the load switched.	
We recommend gold plated contacts for all intrinsically safe and other applications with low voltage/power.	

Operating life time

Normal expected service life (expressed in the number of cycles over the full adjustment range) is appr. 1 million for the pressure switch. This may be extended to 2.5 million cycles max. if only a part of the adjustment range is used (about 20%).

Switch sensor life may also be effected negatively by:

- Media not compatible with the wetted materials.
- Too high switch cycling speed or more than 20 cycles per minute.
- System cycling pressure exceeding the top of the adjustable range.

Operating Instructions

**Single/Dual Metal Diaphragm Pressure Switches D1T/D2T
Single/Dual Metal Diaphragm Differential Pressure Switches DPD1T/DPD2T**



1	Intended Applications	2
2	Safety Instructions	2
3	Standards	3
4	Warranty/Guaranty	3
5	Installation/Commissioning	4
6	Maintenance/Cleaning	8
7	Technical Data	9

Barksdale GmbH
Dorn-Assenheimer Straße 27
D-61203 Reichelsheim

Phone: +49 (6035) 949-0
Fax: +49 (6035) 949-111 and 949-113
email: info@barksdale.de
Internet: www.barksdale.de

Art. no.: 923-1545
Index G, 08.07.2015



Specifications are subject to changes without notice!

1 Intended Applications

The pressure switches are specifically applied for monitoring and controlling of operations using maximum and minimum pressures. A micro switch triggers an electrical signal when minimum or maximum pressure are reached.

DANGER

The switch may only be used in the specified fields of application (see type label).

The temperature has to be within the specified ranges, the pressure values and the electrical rating must not exceed the values specified.

Observe also the applicable national safety instructions for assembly, commissioning and operation of the switch.

The switch is not designed to be used as the only safety relevant element in pressurized systems according to DGR 97/23/EC.

Without special provisions/actions, pressure switches must not be used for combustible gas or pure hydrogen applications.

2 Safety Instructions

The safety instructions are intended to protect the user from dangerous situations and/or material damage.

In the operating instructions the seriousness of the potential risk is designated by the following signal words:

DANGER

Refers to imminent danger to men.
Nonobservance may result in fatal injuries.

WARNING

Refers to a recognizable danger.
Nonobservance may result in fatal injuries, and destroy the equipment or plant parts.

CAUTION

Refers to a danger.
Nonobservance may result in light injuries and material damage to the equipment and/or to the plant.

	IMPORTANT
Refers to important information essential to the user.	

	Disposal
The equipment must be disposed of correctly in accordance with the local regulations for electric/electronic equipment. The equipment must not be disposed of with the household garbage!	

3 Standards

The standards applied during development, manufacture and configuration are listed in the CE conformity and manufacturer's declaration.

4 Warranty/Guaranty

Warranty

Our scope of delivery and services is governed by the legal warranties and warranty periods.

Terms of guaranty

We guaranty for function and material of the single- / dual- pressure switch under normal operating and maintenance conditions in accordance with the statutory provisions.

Loss of guaranty

The agreed guaranty period will expire in case of:

- changes or modifications to the switch/housing/fitting
- incorrect use,
- incorrect installation or
- incorrect handling or operation contrary to the provisions of these operating instructions.

No liability is assumed for any damage resulting therefrom, or any consequential damage.

5 Installation/Commissioning

⚠ DANGER

Only install or uninstall the switch when deenergized (electrically and hydraulically/pneumatically).
Pressure connection and electrical connection must be carried out by trained or instructed personnel according to state-of-the-art standards.
The switch must only be installed in systems where the maximum pressure P_{max} is not exceeded (see type label).

⚠ CAUTION

Alternating pressure - vacuum applications are not authorized in switch types which are suitable for both vacuum and pressure applications.

⚠ WARNING

Pressure peaks and pressure shocks exceeding the maximum operating pressure are inadmissible.

The maximum operating pressure is the upper final value of the adjustable range or, if specified, the pressure indicated as maximum operating pressure. Exceeding the max. operating pressure affects the performance and the life span of the product and may damage it.

Pressure switches must be mounted vibrationless.

⚠ WARNING

Check the switch regularly for functioning.

If the switch does not work properly, stop operation immediately!

🔧 IMPORTANT

All pressure switches are tested for proper functioning before they leave the factory. The factory proof pressures are stated on the type label.

Contact Protection

The micro switches used are normally suitable for both direct and alternating current operation. Inductive, capacitive and lamp loads may, however, considerably reduce the life expectancy of a micro switch and, under extreme circumstances, even damage the contacts.

Depending on the application spark suppression and current limiting is recommended (see succeeding figures).

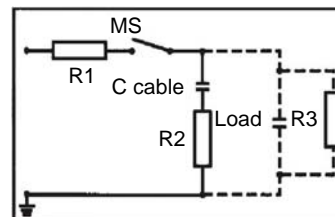

Fig. 1: Protection in case of capacitive loads
R1: Protection against starting current rushes
R2,R3: Protection against high discharge currents

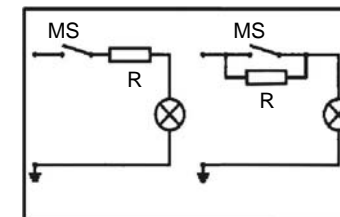

Fig. 2: Lamp load provided with resistance in parallel or series connection to switch of condensators

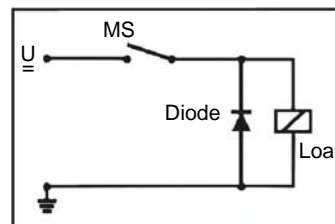

Fig. 3: Protection in case of continuous current and inductive load by recovery diode

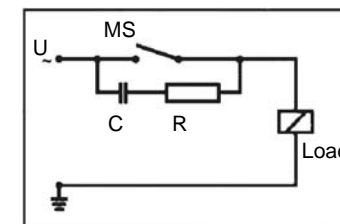



Fig. 4: Protection in case of alternating current and inductive load by RC-link

Set point adjustment

	IMPORTANT
<p>Factory-Provided: pressure (temperature) switch point setting We confirm for pressure (temperature) switches that have been factory set the setting will be detailed on the label name plate.</p> <p>Warranty is not applicable for any changes that may occur due to transportation or installation. For critical applications we recommend the setting is checked and re-set if necessary after installation and wiring of the pressure (temperature) switch.</p>	

In pressure switches, a displacement of the pressure sensing element occurs with a change in pressure. Following the displacement of the pressure sensing element operates a microswitch. Upon delivery of the product, the set points are likely to be found in the middle of the adjustable range. On request, fix set points may be adjusted by our factory. In this event, the point will be indicated on the type plate or any separate plate, i = increasing, d = decreasing.

The set point is adjusted by turning the adjustment screw.

	IMPORTANT
<p>To reach the adjustment screw for pressure switches with housing, remove the cover (see Fig. 7 or Fig. 8).</p>	

Allow pressure switch to reach the desired switch pressure.
Turn adjustment screw clockwise or counterclockwise to actuate the micro switch.

	IMPORTANT						
In case of overpressure:	<table border="0"> <tr> <td>+ ↺ -</td> <td>Counterclockwise rotation:</td> <td>set point increasing</td> </tr> <tr> <td></td> <td>Clockwise rotation:</td> <td>set point decreasing</td> </tr> </table>	+ ↺ -	Counterclockwise rotation:	set point increasing		Clockwise rotation:	set point decreasing
+ ↺ -	Counterclockwise rotation:	set point increasing					
	Clockwise rotation:	set point decreasing					
In case of vacuum:	<table border="0"> <tr> <td>- ↻ +</td> <td>Counterclockwise rotation:</td> <td>set point decreasing</td> </tr> <tr> <td></td> <td>Clockwise rotation:</td> <td>set point increasing</td> </tr> </table>	- ↻ +	Counterclockwise rotation:	set point decreasing		Clockwise rotation:	set point increasing
- ↻ +	Counterclockwise rotation:	set point decreasing					
	Clockwise rotation:	set point increasing					

	IMPORTANT
<p>Please consult the wiring diagram for the contact status at atmospheric pressure (see Fig. 5).</p>	

	IMPORTANT
<p>Particularly important for small pressures! Set point adjustment must be performed in installation position.</p>	

Precise adjustment of set point to actuate on increasing pressure

Lower system pressure to 0 bar.
Increase pressure slowly and check if micro switch is actuated at desired switch pressure.
If necessary, readjust by turning the adjustment screw
Repeat preceding steps until microswitch operates at desired switch pressure.

Precise adjustment of set point to actuate on decreasing pressure

Increase pressure up to a point clearly above the desired switch pressure (at least, switch pressure plus max. hysteresis; not above max. operating pressure).
Lower pressure slowly and check if micro switch is actuated at desired switch pressure.
If necessary, readjust by turning the adjustment screw
Repeat preceding steps until microswitch operates at desired switch pressure.
Following the adjustment of all set points, each set point must be checked and, if necessary, be readjusted.

	IMPORTANT
<p>The adjustment of several set points occurs for each set point as specified above.</p>	

Wiring Code for all Types (Contact status at atm. pressure)

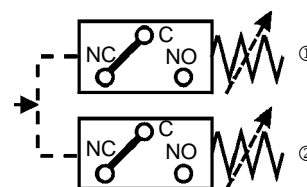

Power circuit ①	Power circuit ②
C = purple	C = brown
NC = blue	NC = orange
NO = red	NO = black

at vacuum NC/NO vice versa

Fig. 5: Wiring Code

Use in Hazardous Locations

Pressure switches with T-housing are marked as **Ex i** intrinsically safe. This switch must be operated with a certified switch amplifier .

The wiring between switch and **Ex i** isolation amplifier must meet the local safety requirements.

The customer must provide for a highly conductive connection between switch and grounding.

 WARNING
With option Ex i: The models having light-alloy (aluminium) enclosures or enclosure parts must be protected against all impact or friction which can ignite the explosive atmosphere.

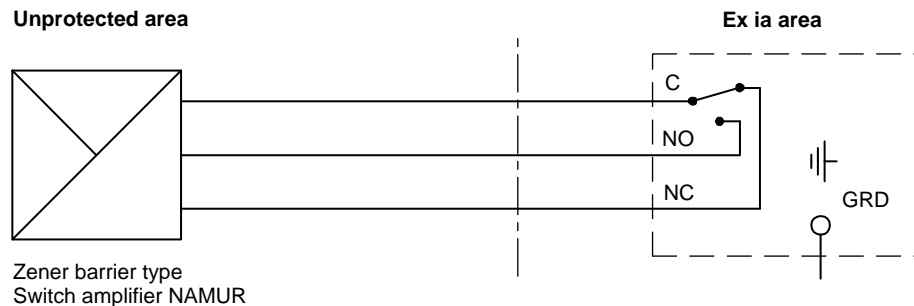

Fig. 6: Operation of pressure switches in intrinsically safe areas

6 Maintenance/Cleaning

Maintenance

The pressure switch is maintenance free, however, the country specific test intervals for preventive maintenance in plants, the PED guideline are to be carried out at all times. Checking the set points lies within the discretion of the user.

Small setpoint drifts may occur during the initial use of the switch (run-in period). To minimize the setpoint drift we can perform a run-in (ageing) process in our works on request. Larger or continuing setpoints drifts during the normal use of the switch may indicate that the measuring system is not used correctly within the specified limits, exceeding the design criteria or is worn-out. This might lead to metal fatigue of the measuring system and it therefore should be replaced before an ultimate rupture of the metal diaphragm might take place. Please consult your supplier or Barksdale directly for guidelines.

7 Technical Data

See data sheet

Dimensions in mm (inch)

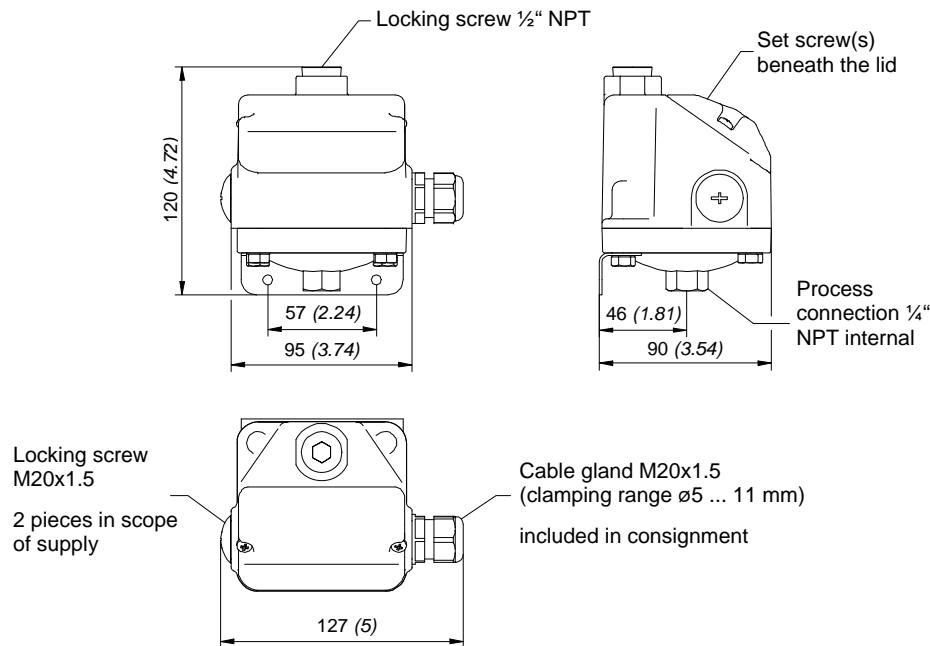

Fig. 7: Metal-diaphragm pressure switch type D1T .../D2T ...

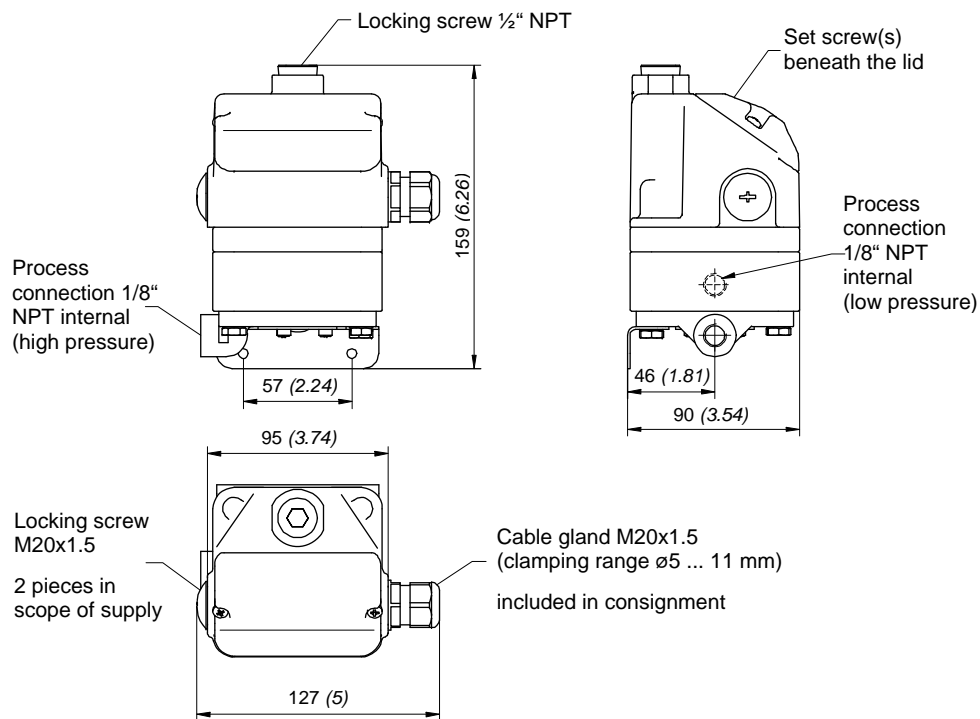

Fig. 8 Metal-diaphragm differential pressure switch type DPD1T .../DPD2T ...

Approval data for Ex i switches (DT and DPDT)

Approval: II 1 G D Ex ia IIC Ga
Ex ia IIIC T100°C Da

Certificate no.: ISSeP08ATEX016X

Permissible ambient temperature: -40 °C ... +75 °C

Electrical data for intrinsically safe application: U_i = 28V li = 50 mA
Ci = 40 pF Li = 4 μH

Standards applied: IEC 60079-0 : 2011, IEC 60079-11 : 2011, IEC 60079-26 : 2006

Adjustable Ranges Pressure Switch Type DPD1T/DPD2T

Pressure range code	Adjustable range [bar] * Differential pressure		Max. operating pressure [bar]	Proof pressure [bar] (short term)	Max. hysteresis of switch types (end of range)	
	Increasing pressure	Decreasing pressure			H, GH [bar]	M, GM [bar]
Overpressure						
3SS	0.02 ... 0,2	0.002 ... 0.2	0.5	0.7	0.01	0.02
18SS	0.05 ... 1.2	0.030 ... 1.2	3.0	4.0	0.02	0.05
80SS	0.40 ... 5.4	0.030 ... 5.2	8.0	10.7	0.14	0.32
150SS	0.70 ... 10.2	0.100 ... 9.7	15.0	20.0	0.26	0.60

* Static operating pressures up to 28 bar possible. Differential pressure of the adjustable range must not be exceeded.

Adjustable Ranges Pressure Switch Type D1T/D2T

Pressure range code	Adjustable range [bar]		Max operation pressure [bar]	Proof pressure [bar] (short term)	Max. hysteresis of switch types (end of range)	
	Increasing pressure	Decreasing pressure			H, GH [bar]	M, GM [bar]
Overpressure						
2SS	0.005 ... 0.11	0.001 ... 0.110	0.15	0.2	0.004	0.006
3SS	0.012 ... 0.20	0.002 ... 0.196	0.5	0.7	0.004	0.010
18SS	0.050 ... 1.20	0.030 ... 1.200	3.0	4.0	0.010	0.040
80SS	0.300 ... 5.50	0.030 ... 5.300	8.0	10.7	0.100	0.220
150SS	0.500 ... 10.30	0.100 ... 9.900	15.0	20.0	0.180	0.400
Vaccum						
3SS	-0.006 ... -0.20	-0.002 ... -0.196	0.15	0.2	0.004	0.009
18SS	-0.040 ... -1.00	-0.020 ... -0.970	0.5	1.0	0.020	0.060